



Interactive monster

Make a textile object that interacts with the user

How to begin with e-textiles and wearables



This project has received funding from the European Union's Horizon 2020 research and innovation programme under grant agreement No 101006203.

Interactive monster:

Color composition +
textiles + electronics

Get the LED to shine in
your favorite color
and make your own
textile character.





What will we learn today?

We will remember how a **LED** and its polarity are working.

We will discover a new type of LED:
The **RGB**

We will meet a new material:
The **velostat**

We will sew a laser cut **textile character**

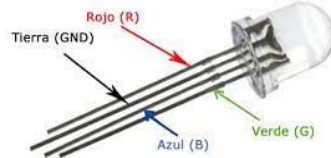



Let's document!

For these LEDs, the longest leg is not necessarily the positive (+) one.

Common anode (CA)

Plus (+) is the longest pin

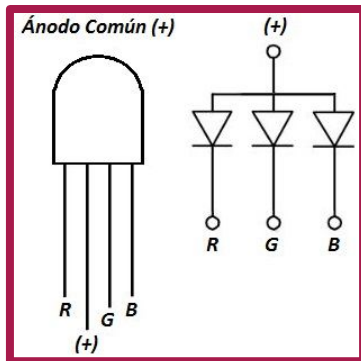

Common cathode (CC)

Minus (-) is the longest pin

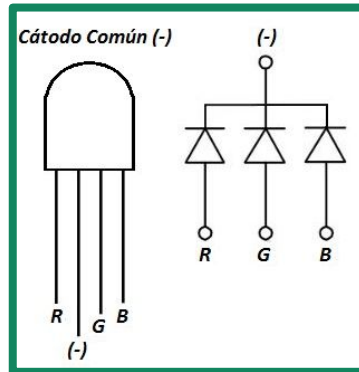

For this activity

Check (next slide) that you have a **CC** RGB LED

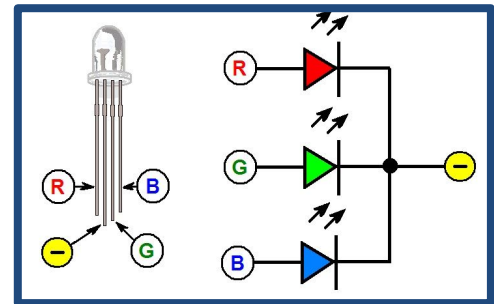



Let's check that we have a common cathode RGB!

1. Identify the longest leg

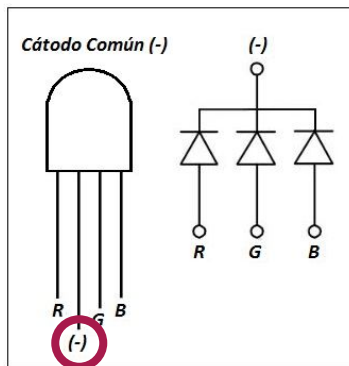

2. Place the battery (+) on the longest leg

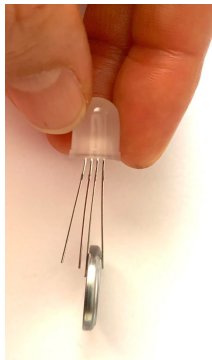

It doesn't light!

3. Place the battery (-) on the longest leg

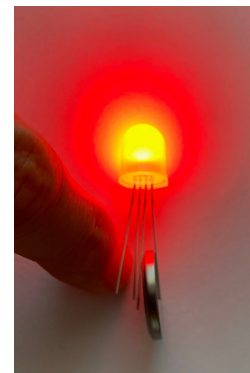

It ligths!



Can you think of a way to create the **turquoise** color ?

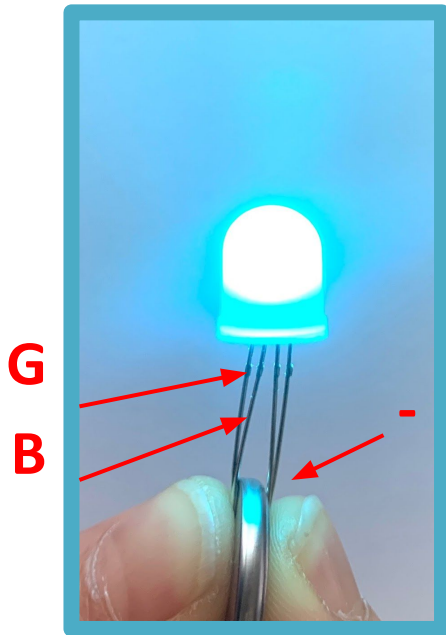

The turquoise color is composed of blue and green, so if you put the B and G legs connected to the (+) and the long leg to the (-) the LED will produce a turquoise color.



VELOSTAT :
**It is a material which the
electrical resistance varies
when it is pushed on**



Velostat

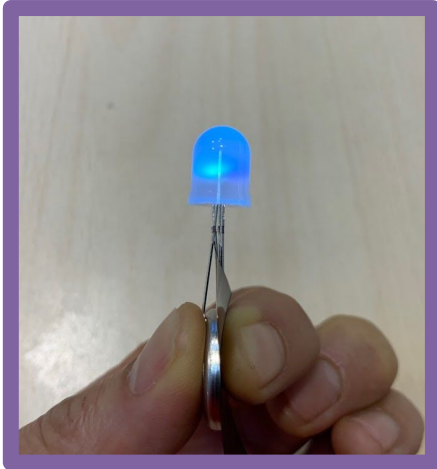

**Put the piece of velostat between one of the leg of the LED and the battery.
What happens if you vary the pressure you apply on it ?**



Learning by DOing

**Now we are going to make
the assembly of the
circuit on a rectangle
of Goma EVA**



List of materials



- 1** LED RGB (10 mm)
- 2** BATTERY
- 3** CONDUCTIVE TAPE
- 4** GOMA EVA(50x80mm)
- 5** VELOSTAT
- 6** PIECES OF FELT ([cutting file](#))



Making the electrical circuit 1

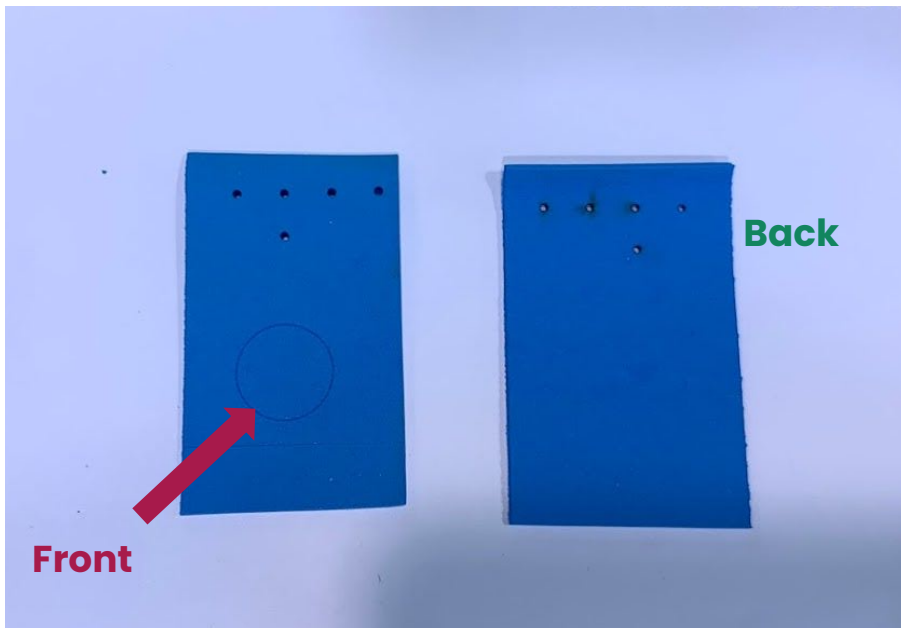

Identify the two parts of the Goma Eva:

The **front part** is the one with the circle engraved, for the battery.



Making the electrical circuit 2

1

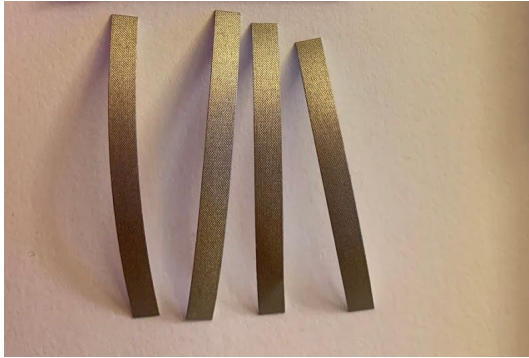

2

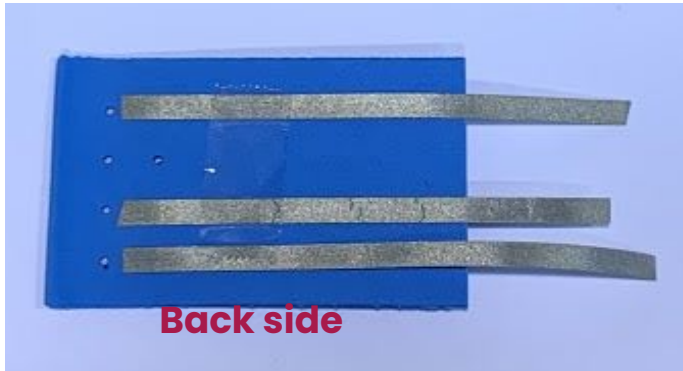

1 Cut 4 pieces of 8cm of conductive tape.

2 stick 3 of them on the **back side** as indicated on the picture.

Do not cut excess tape.



Making the electrical circuit 3

1

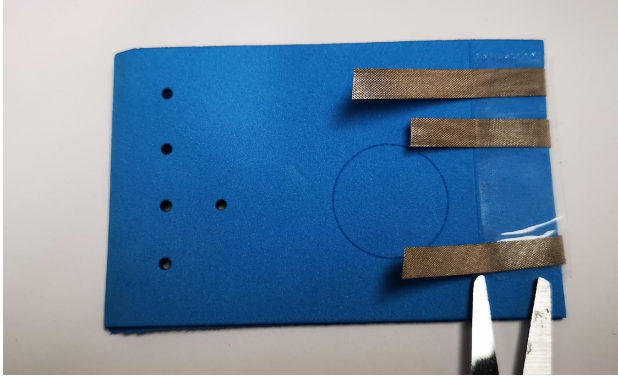

2

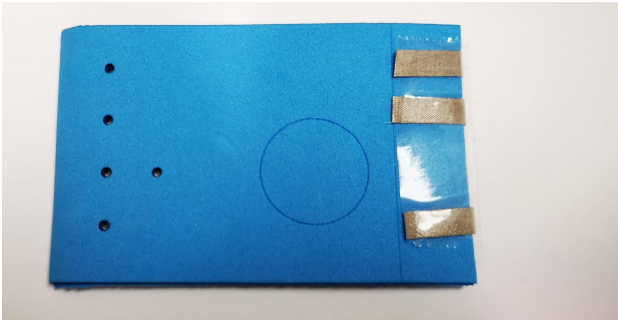

1 Fold the excess tape to the front part.

2 Cut the tape going beyond the line.



Making the electrical circuit 4

1

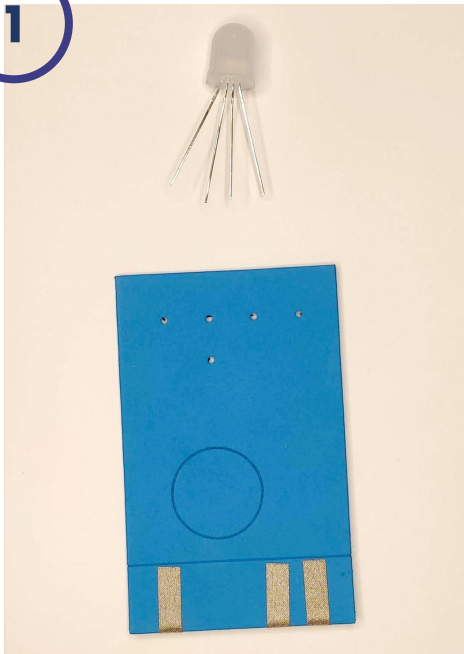

2

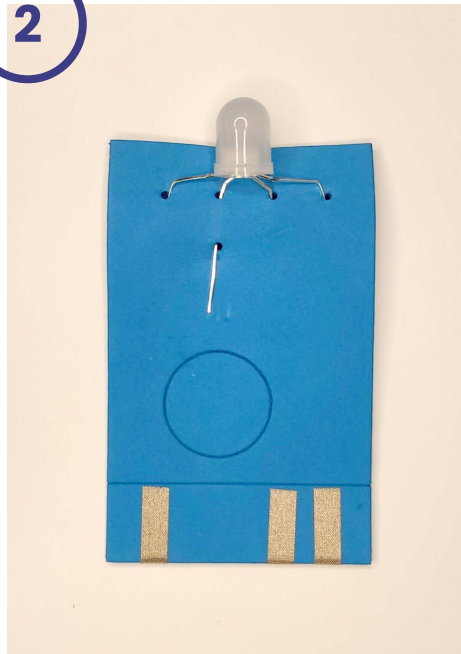

1 Align the longest leg in the row with 2 holes

2 insert the LED legs in the Goma Eva holes



Making the electrical circuit 5

1

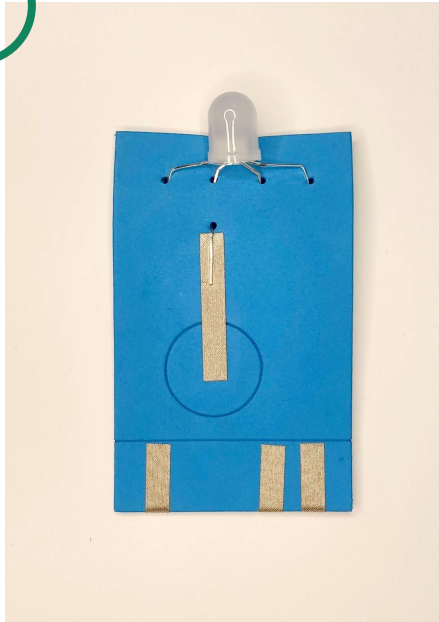

2

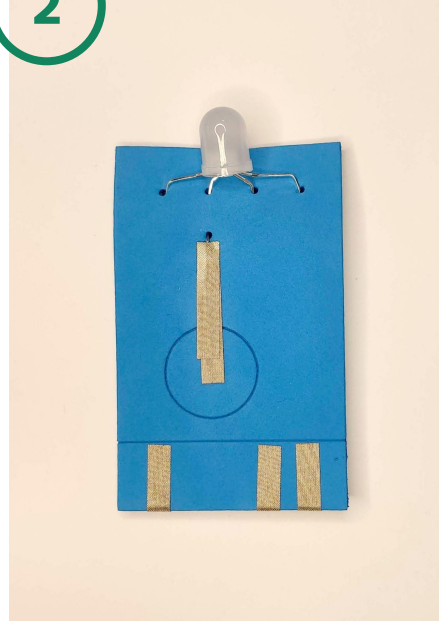

1 Stick the 4th piece of conductive tape, from UNDER the longest leg of the LED, to the battery footprint.

2 Secure the leg on the track with another piece of tape on top of it



Making the electrical circuit 6

1

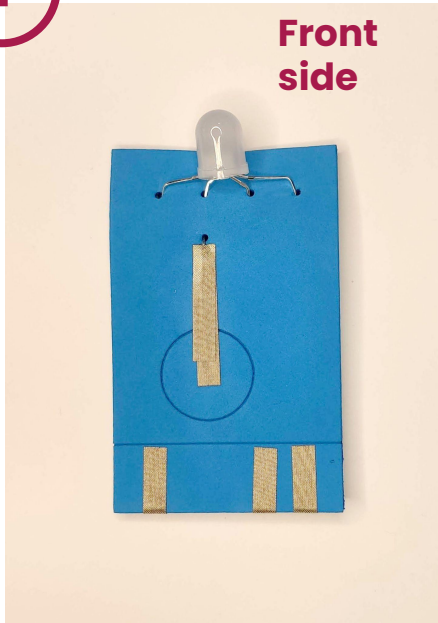

2



1 Put a piece of tape under and on the leg is our way to "solder" and secure the circuit. Like a sandwich

2 Repeat the "soldering" process for each leg of the LED.



Connecting the battery

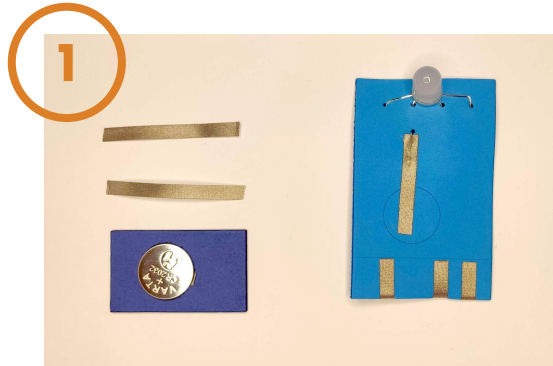

1 Place the battery in the piece of Goma Eva, the (+) has to be facing up, as indicated on the photo.

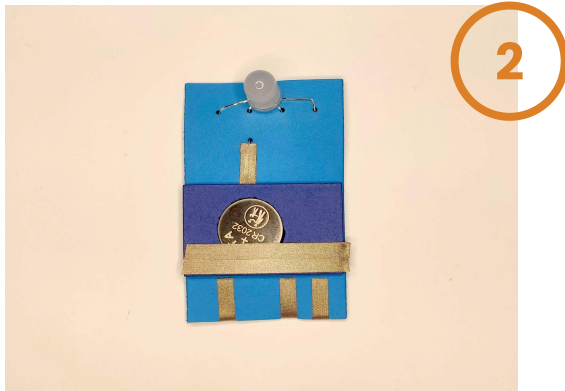

2 Stick 2 strips of conductive tape, touching each other, at the bottom of the Goma Eva rectangle.



Connecting the battery

1

2

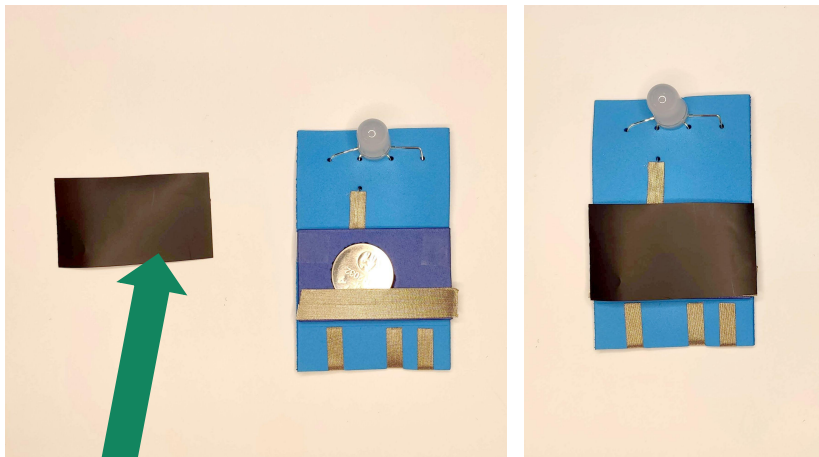

Velostat

1 Place the Goma Eva "battery holder" on the circuit, as indicated on the picture

2 Place the piece of **Velostat** on the battery.



Secure the circuit

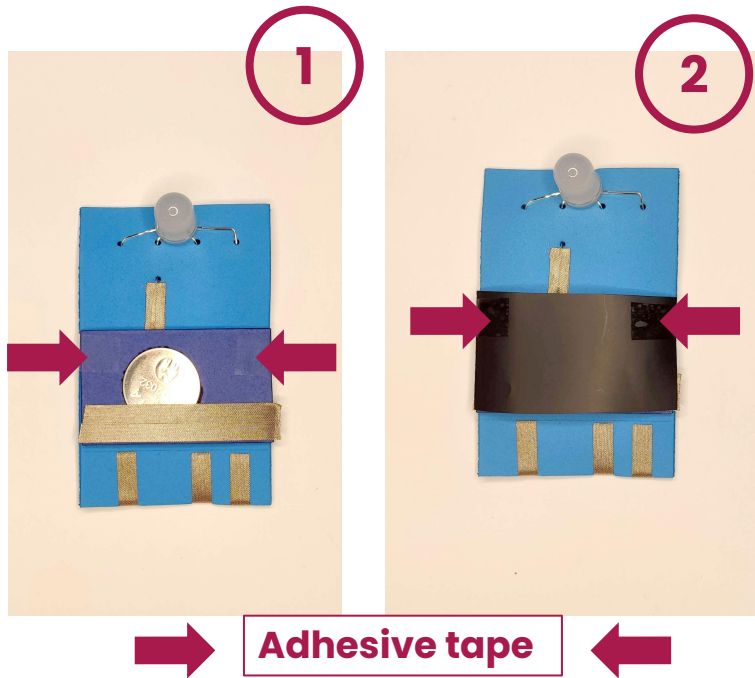

1 Secure the battery holder position with a piece of adhesive tape.

2. Repeat the operation to secure the piece of Velostat



Make the switch

1

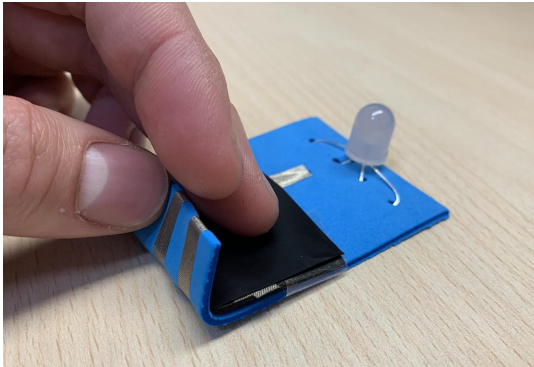

2

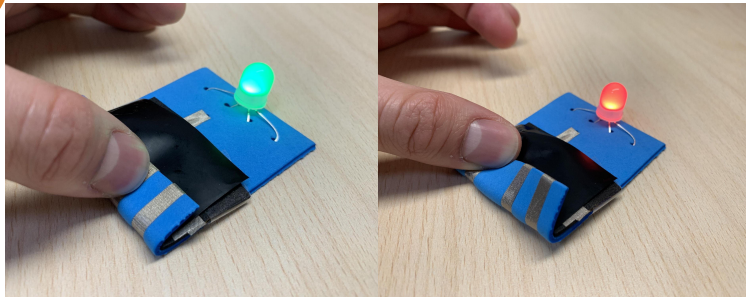

1 Fold the bottom part on the battery holder, and attach it loosely with adhesive tape. The LED should turn off if no pressure is applied.

2 Press each track of the circuit on the Velostat surface, and observe how the LED colors are changing.



Challenge: Get the color **TURQUOISE**

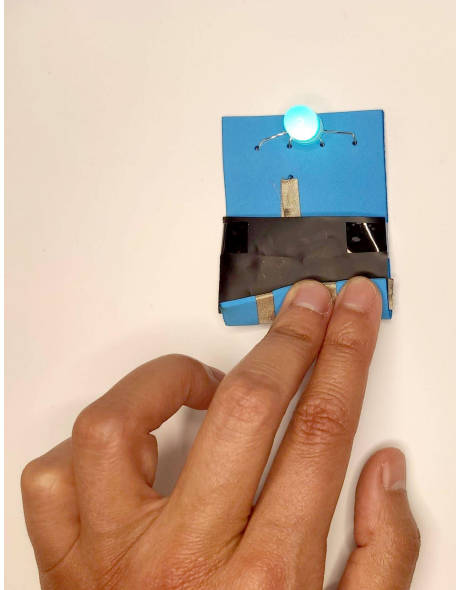

The color turquoise is composed of blue and green, by pressing these color's tracks at the same time we can make color variations.

Plus, the velostat allows us to vary the intensity of each color..



**Document in your notebook
how to get other colors such
as :
Pink, purple, yellow or orange**



Next step

We are going to integrate the circuit you just built into a Felt character



Making the character



For this part you will need :

- Pieces of colored felt
- Felt character
- Needle and thread
- Scissors
- The circuit you made



Making the character



Thread the thread in the needle, making a chubby knot at the end, so that it is caught in the hole.

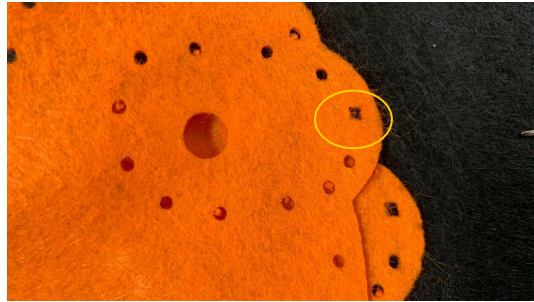

Locate the squared holes in both parts of the character to make them coincide.



Sewing

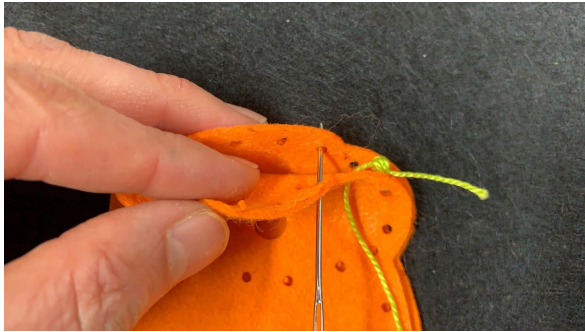

We'll start by introducing the needle through the inside of the felt piece.



Then, sew each hole, going from one side to the other in order to hang both parts of felt together.



Sewing

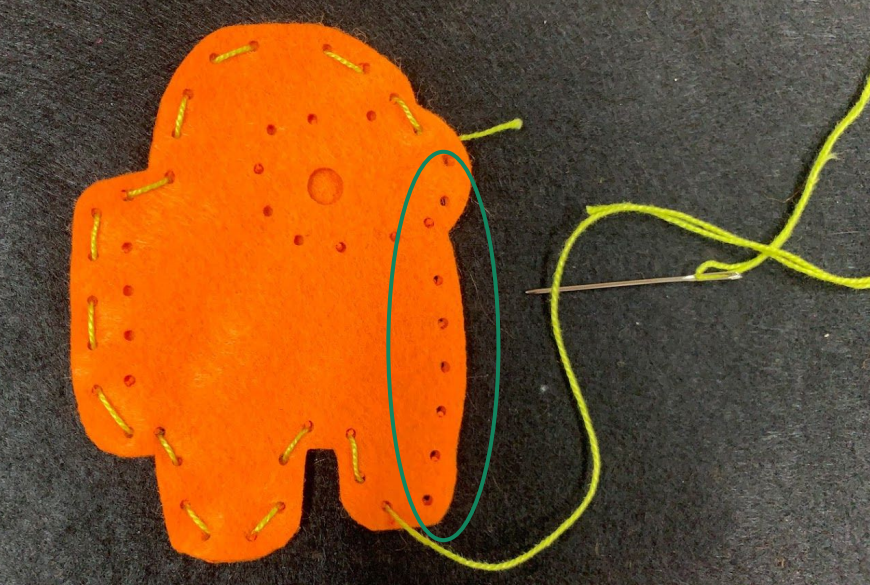

Reserve a part of the character without sewing it, in order to introduce the electronic circuit.



Placing the circuit inside the monster

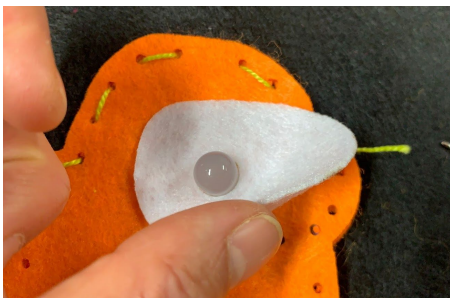

Introduce the circuit by placing the LED in the hole of the felt pattern.



Sewing the last part



Finish sewing and make a knot to secure your work.



Next step

Challenge :

**How would you make your
own character ?
Ready to design it ?**



Next step

Share your creations :

**We love to see different
models, please , share yours
at...**

sh mak s

Thank you

www.shemakes.eu



This project has received funding from the European Union's Horizon 2020 research and innovation programme under grant agreement No 101006203.